

835/836 Gate Control Board

Firmware Version 31 and up

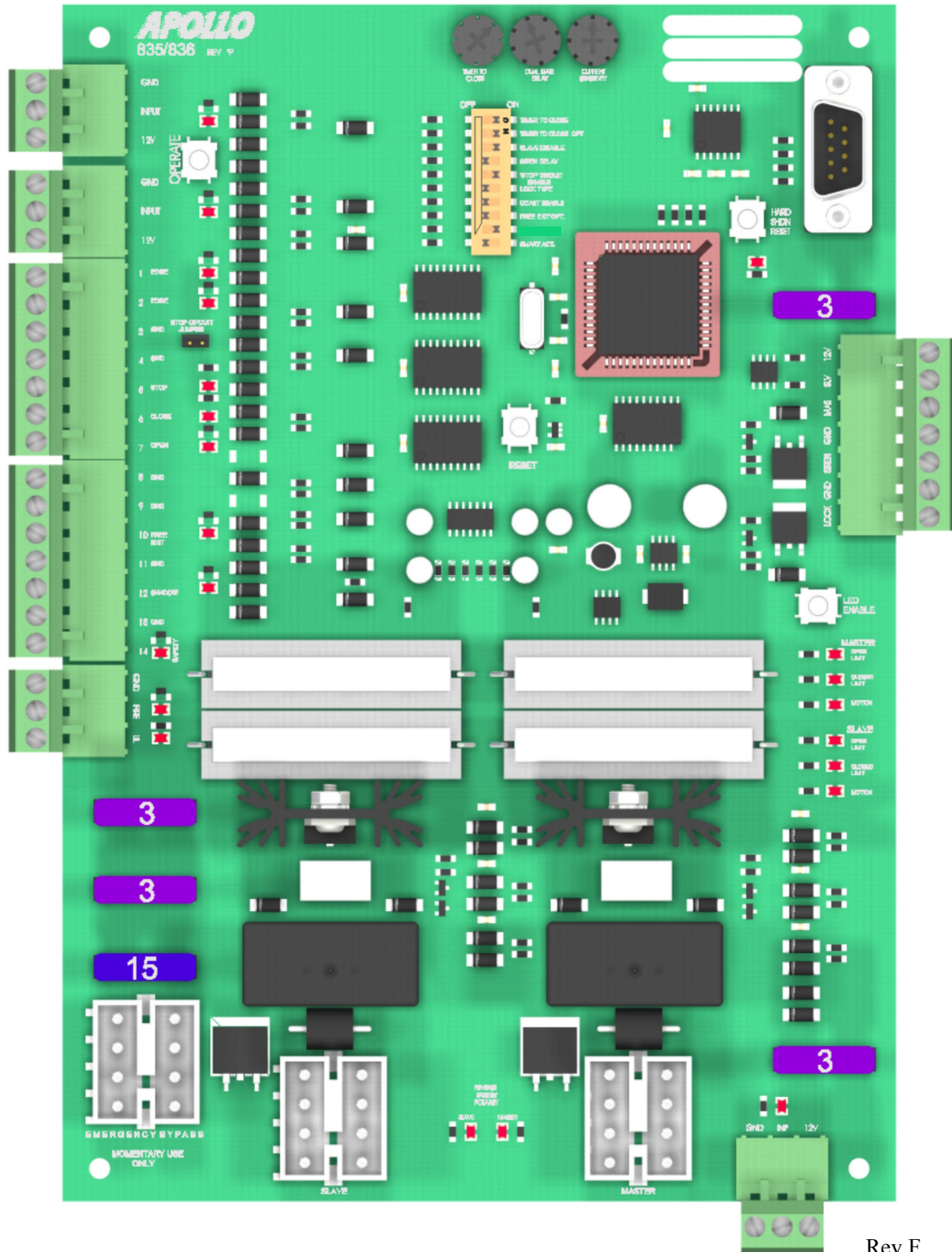

PROGRAMMING INSTRUCTIONS

Once the operator is installed or if the control board is replaced, you will need to program the control board for proper current sensing. The operator should be functional and the open and close limits set.

1. Push and hold the **LED ENABLE** button for five seconds.

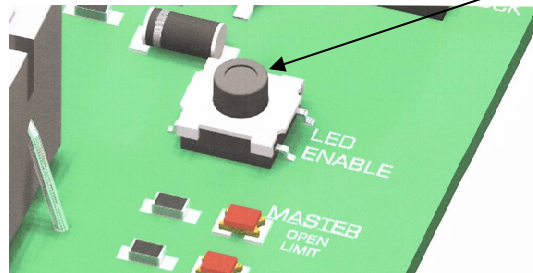

The “**STOP**” LED will blink indicating the board is in learn mode.

2. Cycle the gate three full times (*must read open and close limit switches each cycle*).

The “**STOP**” LED will now stay illuminated.

3. Adjust the current sensitivity pot to insure safe operation

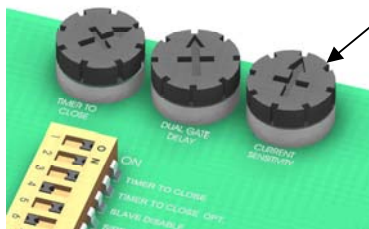

The current sensitivity may be readjusted at any time without relearning the board.

Periodically check the current sensitivity for safe operation.

835/836 Control Board Parts Identification

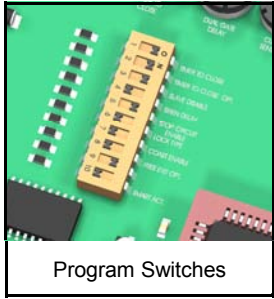

Program Switches



Timer To Close -
Dual Gate Delay -
Current Sensitivity -
Adjustments

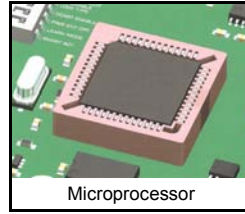

Microprocessor

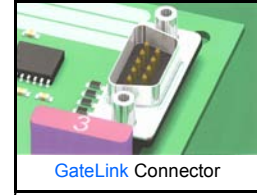

GateLink Connector

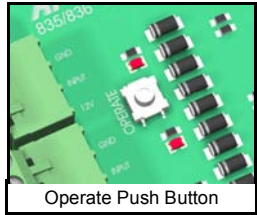

Operate Push Button

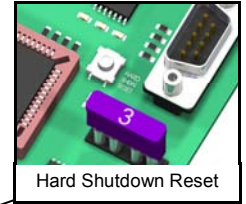
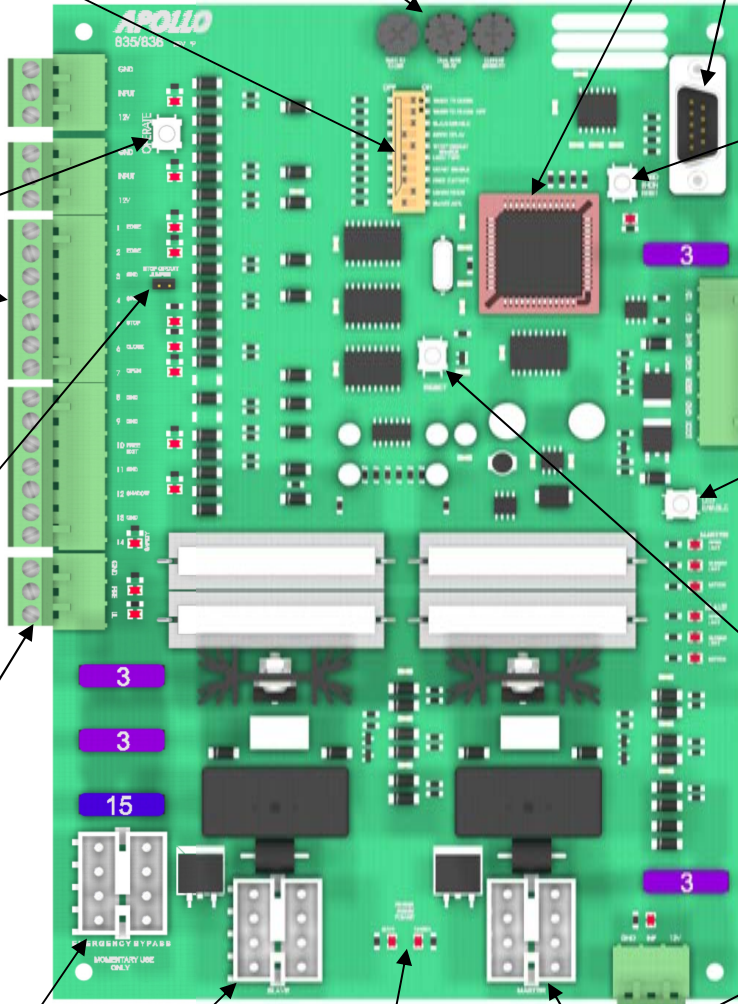

Hard Shutdown Reset

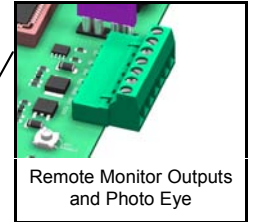

Remote Monitor Outputs
and Photo Eye

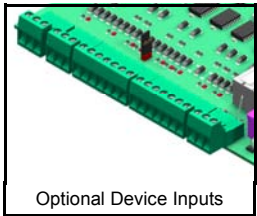

Optional Device Inputs

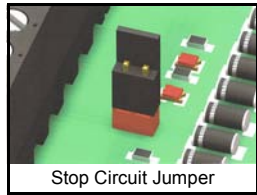

Stop Circuit Jumper

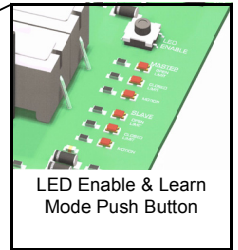

LED Enable & Learn
Mode Push Button

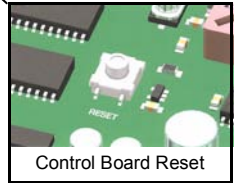

Control Board Reset

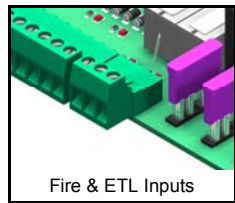

Fire & ETL Inputs

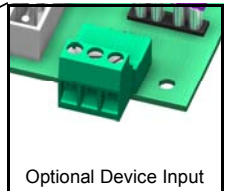

Optional Device Input

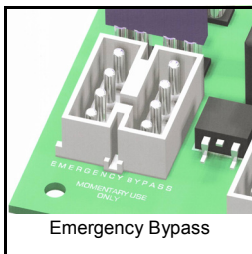

Emergency Bypass

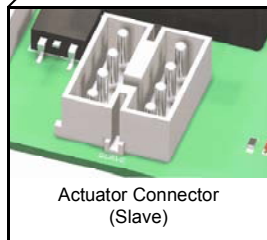

Actuator Connector
(Slave)

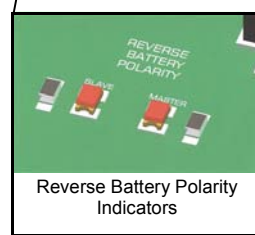

Reverse Battery Polarity
Indicators

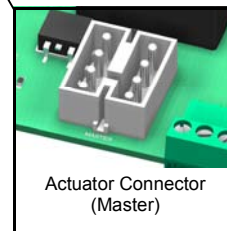

Actuator Connector
(Master)

Actuator Connector

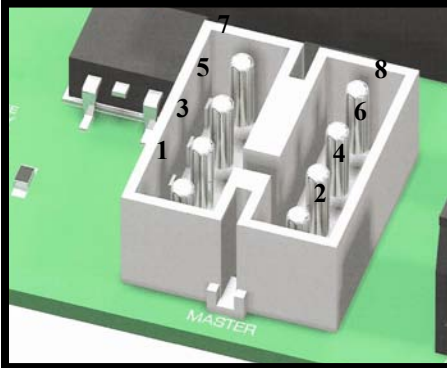

Board	Actuator Cable	Function
Pin 1	Orange	Open Limit
Pin 2	White	Close Limit
Pin 3	Black	Motor (positive on open, negative on close)
Pin 4	Red	Motor (negative on open, positive on close)
Pin 5	Green	Common for both limit switches
Pin 6	Yellow	Feedback from intelligent actuator(816E/816EX)
Pin 7	Black	Battery Negative
Pin 8	Red	Battery Positive

EMERGENCY BYPASS (open only)

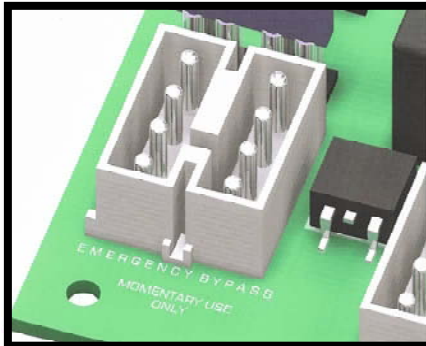

Applies battery voltage directly to motor to open gate if control board fails. User must unplug before gate opens to maximum travel or 15 amp fuse will open. Fuse should be checked before returning gate to service.

Remote Outputs and Photo Eye Hookup

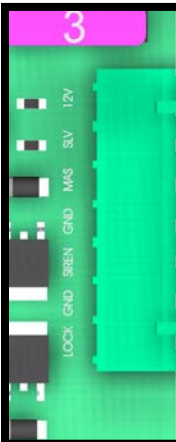

12V	Supplied battery voltage
MAS	Master Operator Indicator (indicates master side of gate is closed) +12V when on closed limit. Ground when off of closed limit.
SLV	Slave Operator Indicator (indicates slave side of gate is closed) +12V when on closed limit. Ground when off of closed limit.
GND	Battery supplied ground
SIREN	Connect to siren + applies +12V when gate(s) are running, or in hard shutdown
GND	Battery supplied ground
LOCK	Connect to lock + (optional) Magnetic or Solenoid type locks (Dip Switch #6 Selectable)

Photo Eye Hookup

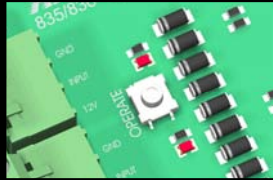

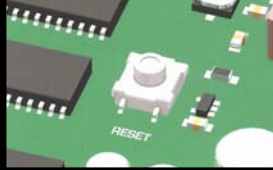

Photo eye / safety loop wiring. Connect the positive power wire of the accessory to 12V. Connect the ground wire of the accessory to MAS (upper right area of the 835/836 board). Connect the relay wires of the accessory as normal: COM to GND. NO to SAFETY (#14) (for a safety device). When the gate operator begins opening (comes off of the closed limits) the MAS terminal will become a ground and will complete the flow of power to the accessory. This will power the accessory up and it will work as normal until the gate gets closed and the MAS terminal switches and the device will power down.

Adjustments

	TIMER TO CLOSE Adjusts time before gate automatically closes. Adjustable 5 to 70 seconds.
	DUAL GATE DELAY Adjusts delay between master and slave operation 0-4 seconds (836 only for use with magnetic, solenoid, and other locking devices)
	CURRENT SENSITIVITY Increases or decreases the Auto Reverse sensitivity.

Push Buttons

	OPERATE When depressed, activates the gate. Used for initial installation and testing.
	Hard Shutdown Reset Resets the operator when the gate current senses twice before fully opening or closing.
	LED ENABLE When depressed, activates LEDs for 15 minutes to assist in installation and troubleshooting. Hold the push button down for five seconds to put the board in program mode.
	RESET Resets the microprocessor. Returns processor to last known state.

Jumpers

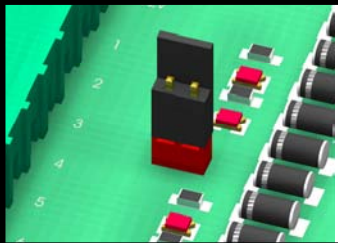
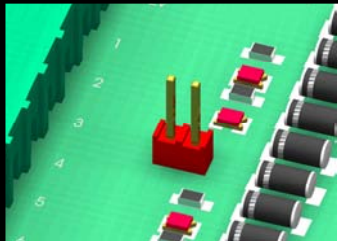
	STOP CIRCUIT JUMPER When the STOP CIRCUIT JUMPER is connected, the gate will operate normally.
	STOP CIRCUIT JUMPER When a 3-button station is connected to the board, the STOP CIRCUIT JUMPER must be removed.

Program Switches

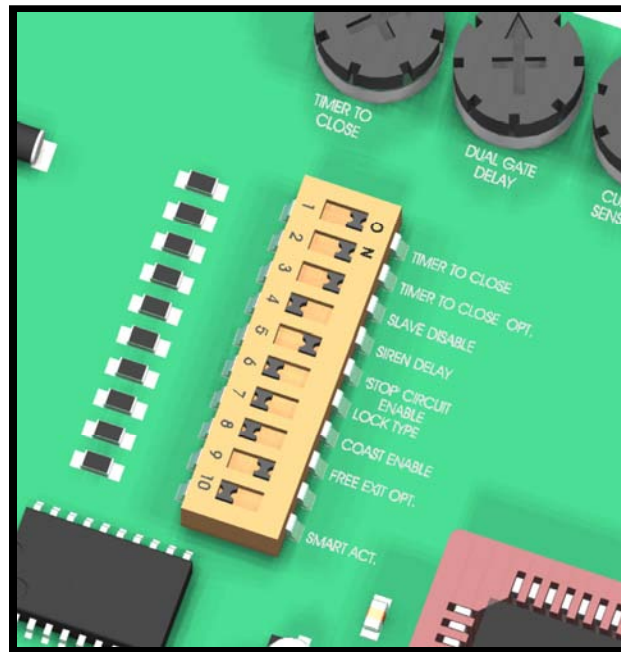

Setting shown are for 416E, 416EX, 7XXX operators and 3500 operators.

OFF

ON

1 TIMER TO CLOSE	Gate does not automatically close.	Gate automatically closes.
2 TIMER TO CLOSE OPT.	Gate automatically closes from any position after opening.	Gate automatically closes only when completely open (open limit engaged).
3 SLAVE DISABLE	Enables slave side (dual gate use).	Disables slave side. (single gate use)
4 SIREN DELAY	Siren (optional) active when gate is moving.	Siren (optional) starts 5 seconds before gate moves.
5 'STOP' CIRCUIT ENABLE	Must hold down open or close buttons to move gate. Gate stops when button released.	Normal operation Momentary open or close input runs gate to limit.
6 LOCK TYPE	For 12V mechanical (solenoid) locks. (+12V for 4 seconds on open cycle)	For 12V magnetic locks. (+12V when on close limit)
7 COAST ENABLE	Gate will brake when at Open or Close limit	Gate will coast (minimally) when it reaches limits.
8 FREE EXIT OPT.	A free exit input will open gate from closed position or after a close cycle only.	A free exit input will open gate from any position after an open or close cycle.
9 NOT USED		
10 SMART ACT.	Off for 416E & 416EX actuators, slide gates, 3500 or when slow down feature is not desired.	Used for 816E & 816EX actuators only (soft start & stop).

Optional Device Inputs

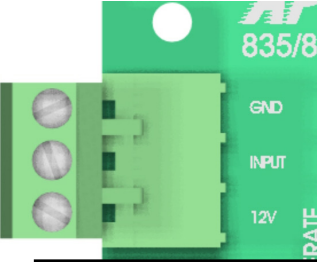
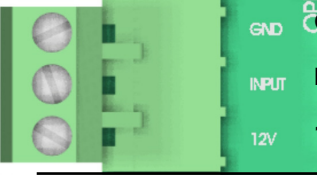
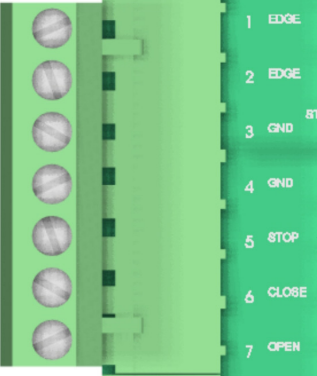
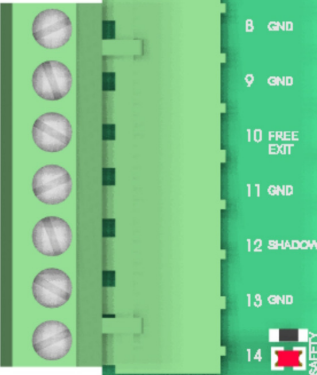
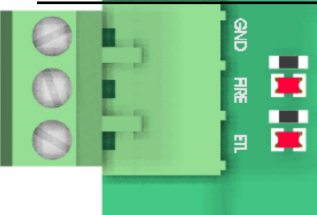
	835/8 GND	GND	Supplied Battery Ground
	INPUT	INP	Activate Gate (Push button activation when momentarily shorted to ground)
	12V	12V	Supplied Battery Voltage (Protected with 3 Amp fuse)
	GND	GND	Supplied Battery Ground
	INPUT	INP	Activate Gate (Push button activation when momentarily shorted to ground)
	12V	12V	Supplied Battery Voltage (Protected with 3 Amp fuse)
	1 EDGE	EDGE	Reverse edge input. When grounded, will stop and reverse gate if closing, resets close timer if gate is open.
	2 EDGE	EDGE	Reverse edge input. When grounded, will stop and reverse gate if closing, resets close timer if gate is open.
	3 GND	GND	Supplied Battery Ground
	4 GND	GND	Supplied Battery Ground
	5 STOP	STOP	Stop input from a 3 button station (must remove STOP CIRCUIT JUMPER) Normally closed
	6 CLOSE	CLOSE	Close input from a 3 button station (see program switch #5 for options)
	7 OPEN	OPEN	Open input from a 3 button station (see program switch #5 for options)
	8 GND	GND	Supplied Battery Ground
	9 GND	GND	Supplied Battery Ground
	10 FREE EXIT	FREE EXIT	Opens gate if closed, stops and reverses gate if closing, resets close timer if gate is open.
	11 GND	GND	Supplied Battery Ground
	12 SHADOW	SHADOW	Resets close timer when gate is open (also referred to as under gate loop)
	13 GND	GND	Supplied Battery Ground
	14 SAFETY	SAFETY	Resets close timer if gate is open, stops and reverses if gate is closing. (Does not open a closed gate)
	GND	GND	Supplied Battery Ground
	FIRE	FIRE	When grounded, opens gate and holds gate open until released. Clears "Hard Shutdown" mode of software.
	UL	UL	When grounded, opens gate and holds gate open until released. Clears "Hard Shutdown" mode of software.

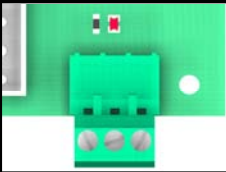
	GND	GND	Supplied Battery Ground
	INP	INP	Activate Gate (Push button activation when momentarily shorted to ground)
	12V	12V	Supplied Battery Voltage (Protected with 3 Amp fuse)

APOLLO *Gate Operators, Inc.*

911 Siren

The 911 Siren is included with all Apollo ETL Gate Operators.

Mount siren in an area that will produce maximum performance (additional wire may be required).

Connect the red wire to the SIREN connector on the Remote Monitor Output Connector block.

Connect the black wire to the GND connector on the Remote Monitor Output Connector block.

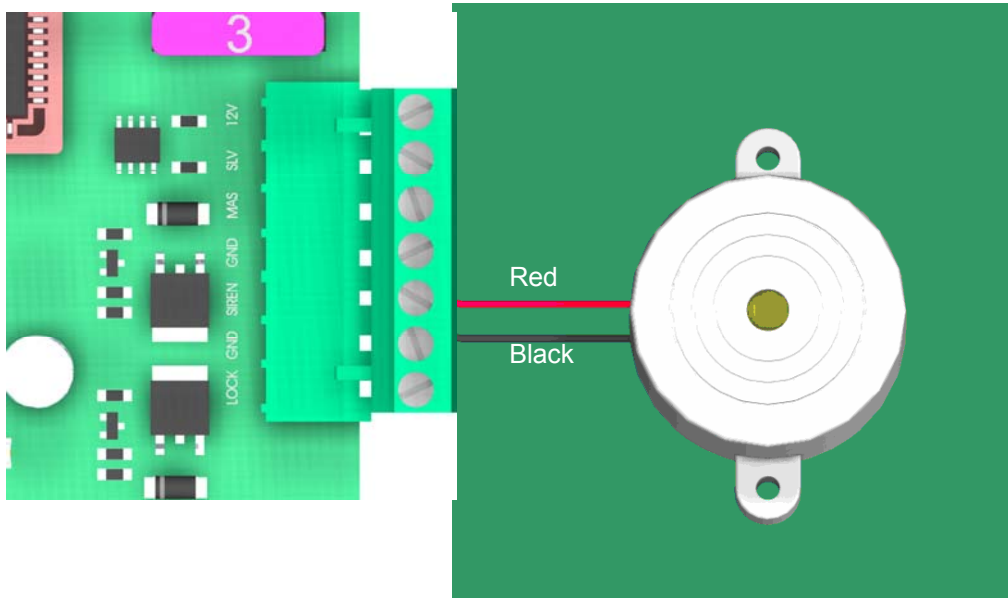

Set Program Switch # 4 as preferred:

ON - Upon activation, Siren will start for 5 seconds before gate(s) begin moving.

OFF - Siren and gate(s) start immediately upon activation.

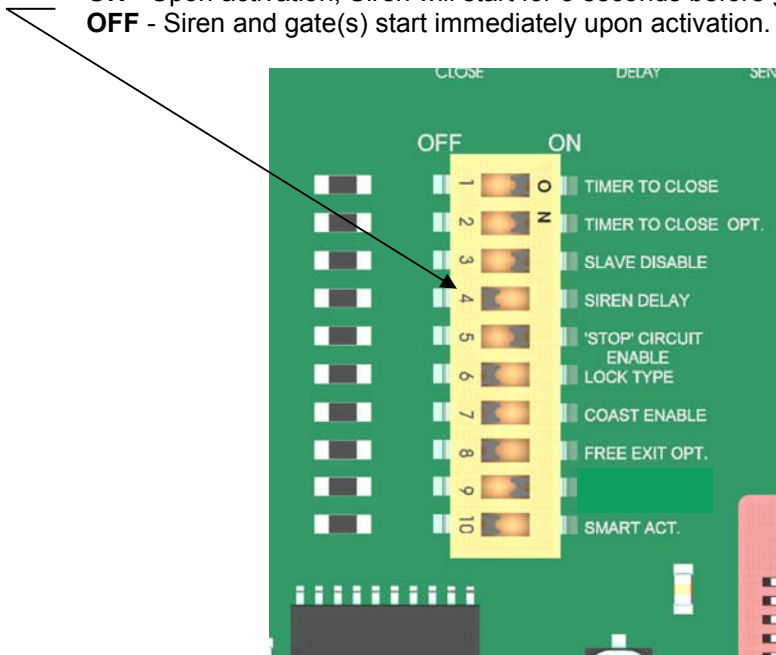

APOLLO *Gate Operators* RECEIVER OPTIONS

Do not confuse the receiver code switches with the red program switches on the gate control board.

Never set all code switches to the same position. Transmitters must match code switches for proper operation.

If power is taken directly from battery or connected as shown below, receiver should be configured for 12VDC

